

# Wnęki w słupach aluminiowych

# Tabliczki typu NTB

# Projektorzy

# Qba

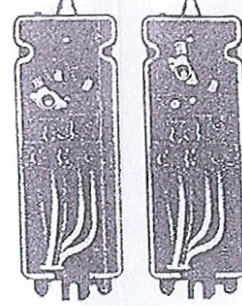
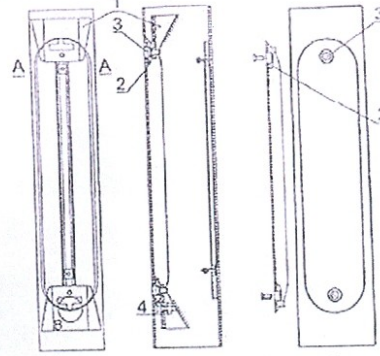
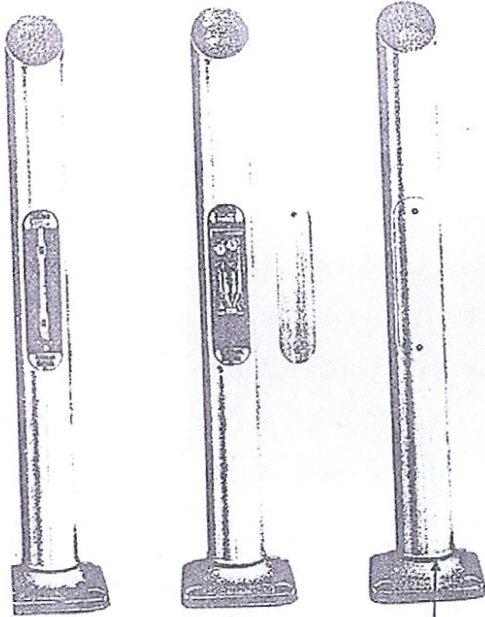

Wnękę  
montujemy w  
gniazdo  
rozstawu między  
przekładkami 275

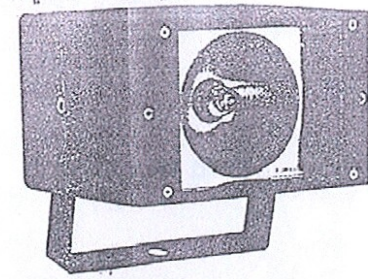

## Areaflood 25/40

## Areaflood 10/15

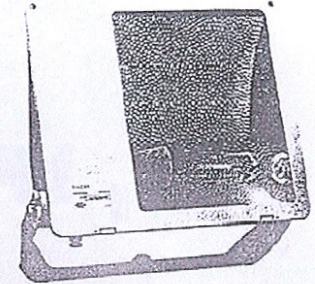
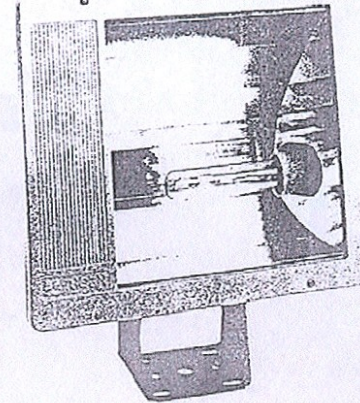

L50x50x4

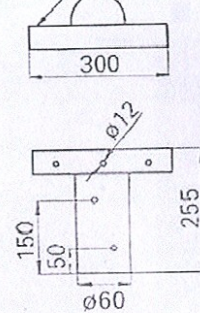

WN-1- Ø60

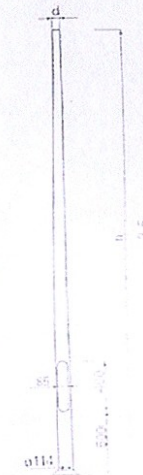

słup SAL-3,5/60

# Słupy aluminiowe

1. Zamek wnęki
2. Zamek pokrywy
3. M8x16 A2 sześciokątne
4. M8x30 A2 śruba zenująca, nakrętka i dwie podkładki

śruba do zamknięcia wnęki:

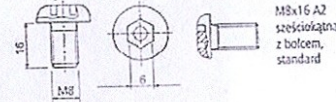

M8x16 A2 sześciokątne z bolcem standard

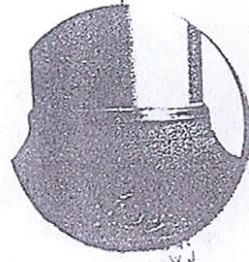
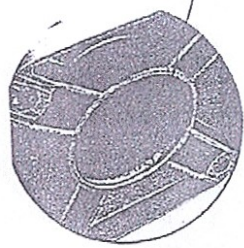

Wydział Bur Invest

# Fundamenty betonowe

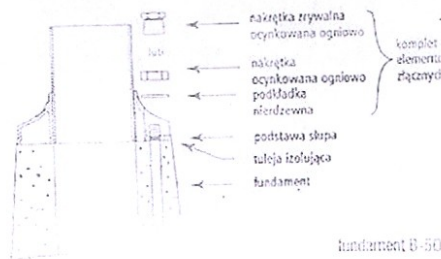

fundament B-60

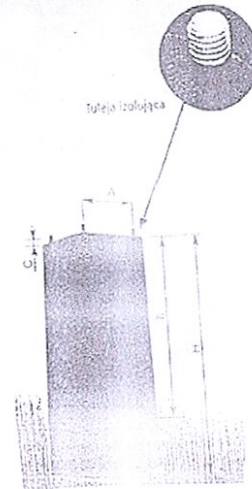

Złącze łącznikowe:

