

Wnęka w słupach aluminiowych

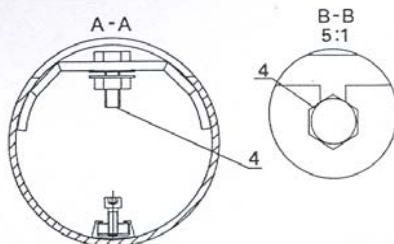

1. Zamek wneki
2. Zamek pokrywy
3. M8x16 A2 sześciokątne
4. M8x30 A2 śruba zerująca, nakrętka i dwie podkładki

Śruba do zamknięcia wneki:

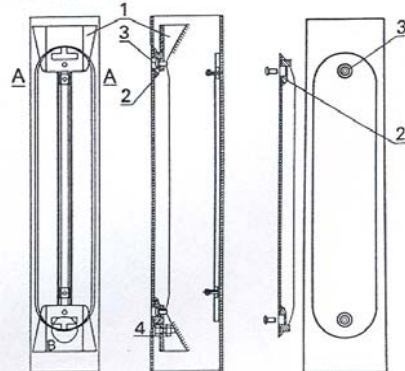
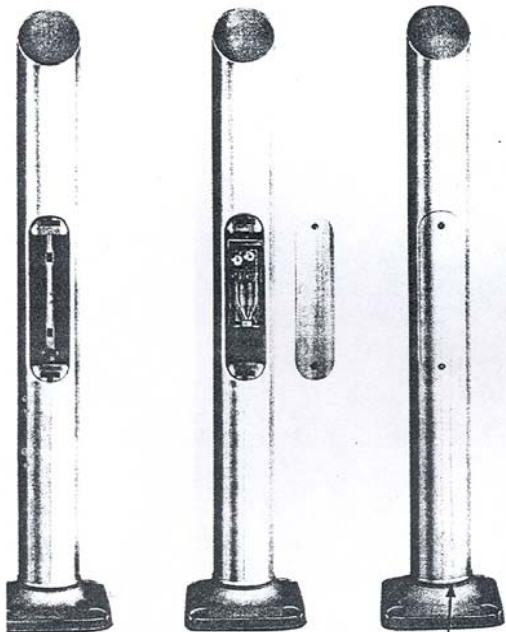
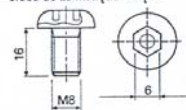

M8x16 A2 sześciokątne z bolcem, standard

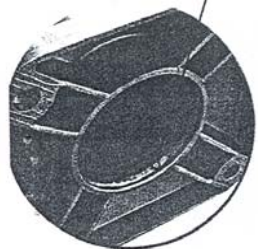

Wydział Bur
Inwest

Fundamenty betonowe

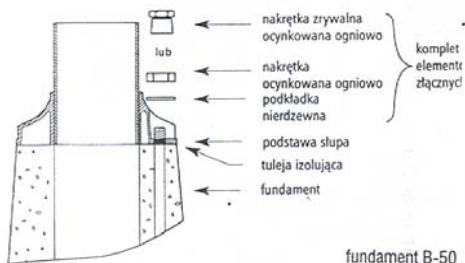

fundament B-50

Tuleja izolująca

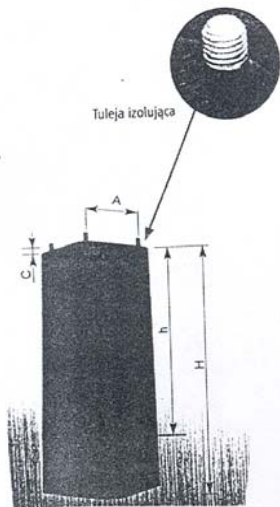

Tabliczki typu NTB

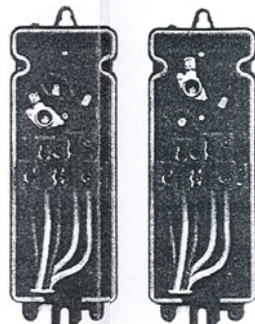

możliwość przekładania gniazd bezpiecznikowych w tabliczce NTB-1

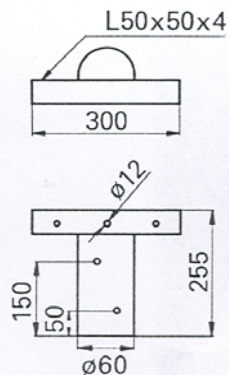

WN-1- Ø60



słup SAL-3,53/60

Słupy aluminiowe

Projektory

Qba

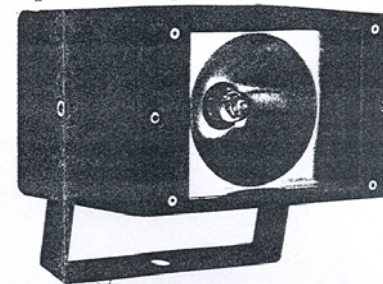

Areaflood 25/40

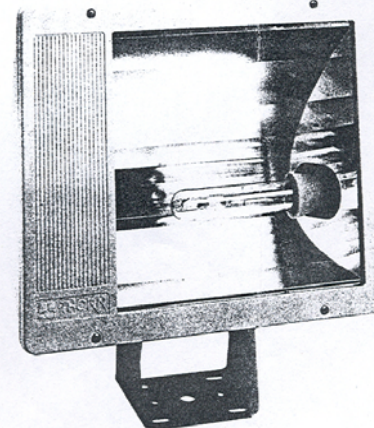

Areaflood 10/15

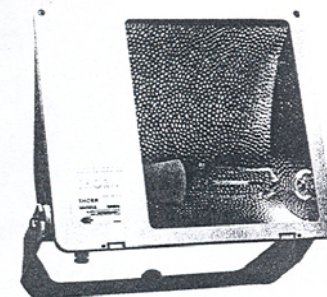

SKP-12

